

Odd-one-Out

20 Logic-Reasoning Cards

using
CREATIVE
Thinking

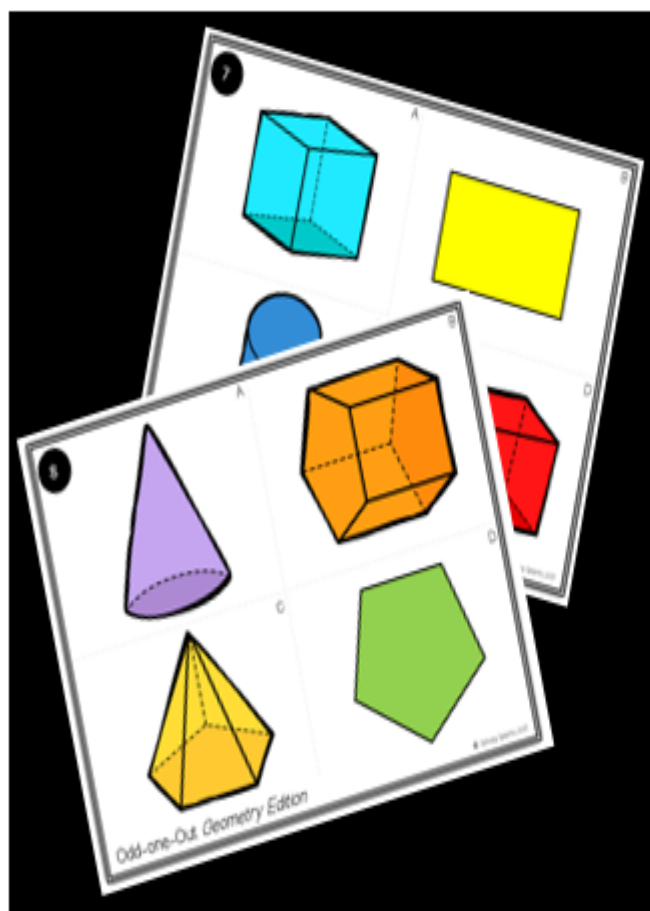

Geometry Edition

NOTES to the TEACHER

This activity is great for fostering **CREATIVE THINKING** and **LOGIC-REASONING** skills.

Suggested Use:

Whole Group Warm-Up
Small Group Discussion
Partners

Included in this Resource:

- **Student Directions:** Kid-friendly explanation on how to use these cards. Perfect for a math station.
- **20 Logic-Reasoning Cards:** Students will use **MATHEMATICAL** reasoning to explain why one picture is the odd-one-out. There are multiple possibilities per card. Student explanations must be reasonable. Once an answer is given, prompt students to search for other solutions. Use icons to introduce new concepts or as teachable moments. The object of this activity is to spark conversation about mathematical concepts.
- **24 COLOR Full Page Cards:** These can be used to project on a screen or as a larger version for small groups.
- **Answer Sheet:** Students will write the letter(s) of odd-one-out in each box.
- **Odd-one-Out Write About It:** Students will use this half-sheet template to explain their answer in a constructed response.
- **SAMPLE ANSWERS: 2 of the Possibilities for Each Card**

Odd-one-Out

Directions

Look at each of the four pictures on a card.
Use your **MATH** thinking to decide which picture is the odd-one-out. Think creatively!
There are more than one answer per card.
How many can you find?

Odd-one-Out *Geometry Edition*

© Spivey Sparks 2017

Odd-one-Out

Directions

Look at each of the four pictures on a card.
Use your **MATH** thinking to decide which picture is the odd-one-out. Think creatively!
There are more than one answer per card.
How many can you find?

Odd-one-Out *Geometry Edition*

© Spivey Sparks 2017

1

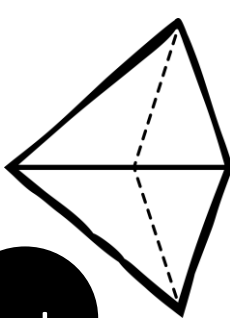
A 

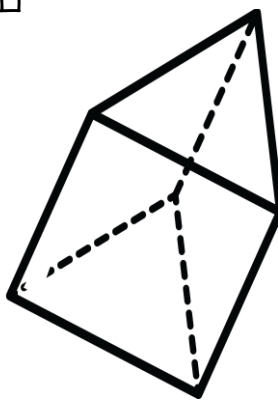
B 

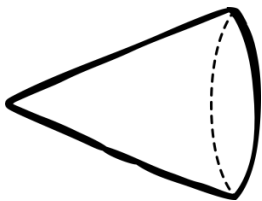
C 

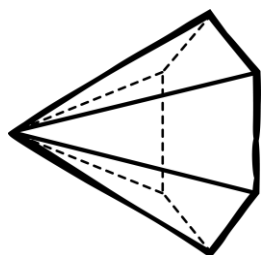
D 

Odd-one-Out Geometry Edition © Spivey Sparks 2017

2

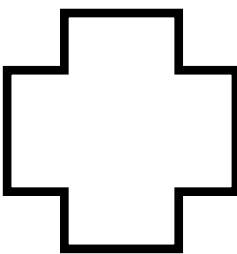
A 

B 

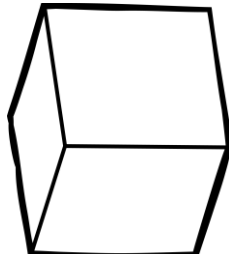
C 

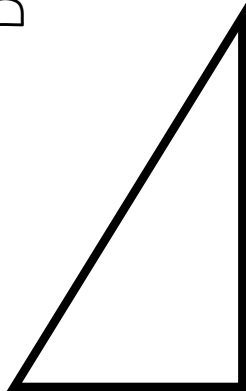
D 

Odd-one-Out Geometry Edition © Spivey Sparks 2017

3

A 

B 

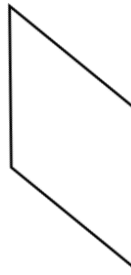
C 

D 

Odd-one-Out Geometry Edition © Spivey Sparks 2017

4

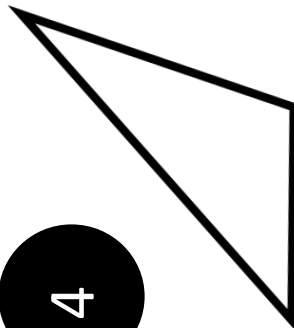
A 

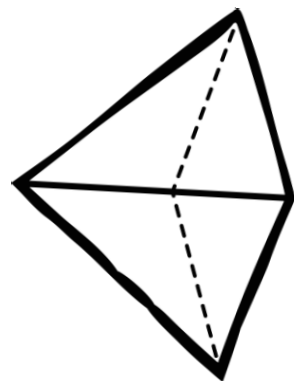
B 

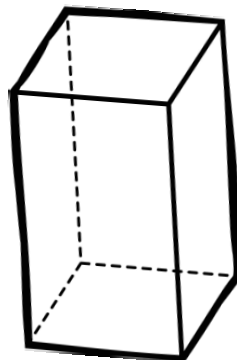
C 

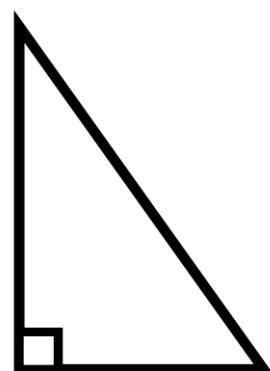
D 

Odd-one-Out Geometry Edition © Spivey Sparks 2017

5

A  A right-angled triangle with a small square at the top-right vertex.

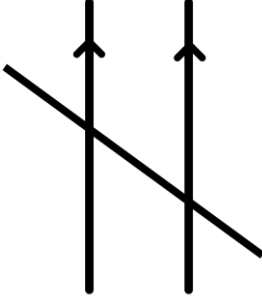
B  Two horizontal parallel lines with arrows, intersected by a transversal line.

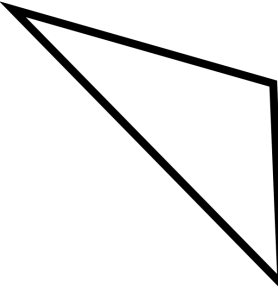
C  A trapezoid with a vertical left side and a shorter vertical right side.

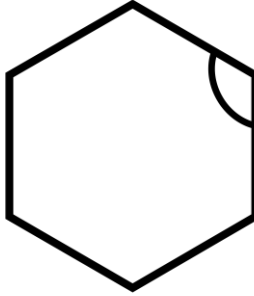
D  A regular hexagon with a small arc drawn on its top-right side.

Odd-one-Out Geometry Edition © Spivey Sparks 2017

6

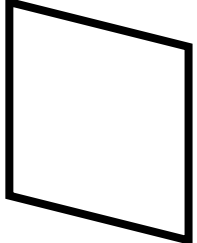
A  A parallelogram.

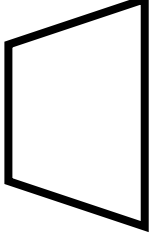
B  A trapezoid with a shorter top side.

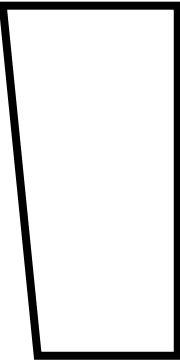
C  A rectangle.

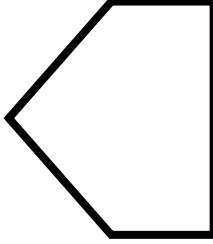
D  A pentagon with a pointed top.

Odd-one-Out Geometry Edition © Spivey Sparks 2017

7

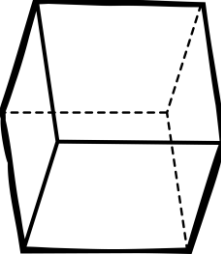
A  A 3D rectangular prism with dashed lines for hidden edges.

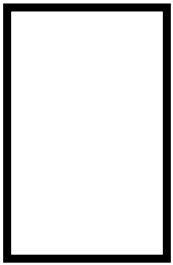
B  A 2D rectangle.

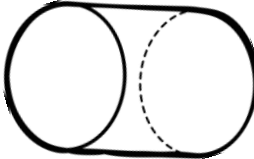
C  A cylinder with dashed lines for the back edge.

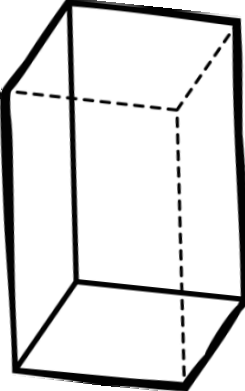
D  A 3D rectangular prism with dashed lines for hidden edges.

Odd-one-Out Geometry Edition © Spivey Sparks 2017

8

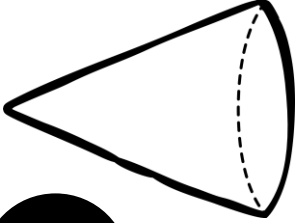
A  A cone with a dashed line for the hidden back edge of the base.

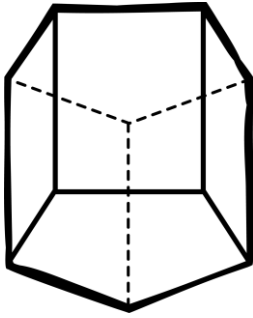
B  A 3D rectangular prism with dashed lines for hidden edges.

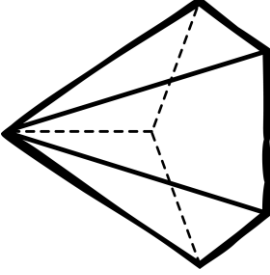
C  A 3D square pyramid with dashed lines for hidden edges.

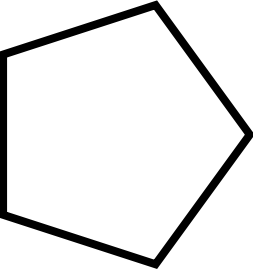
D  A pentagon with a pointed top.

Odd-one-Out Geometry Edition © Spivey Sparks 2017

9

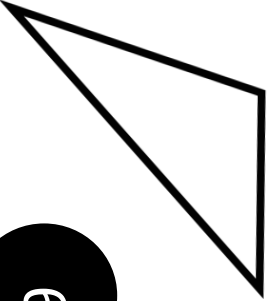
A 

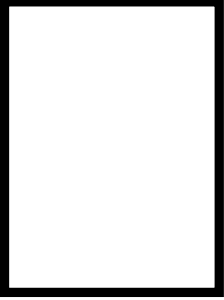
B 

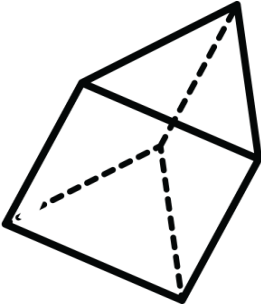
C 

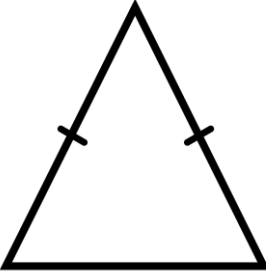
D 

Odd-one-Out Geometry Edition © Spivey Sparks 2017

10

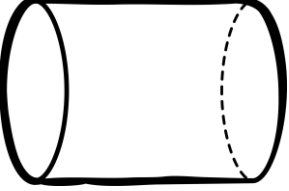
A 

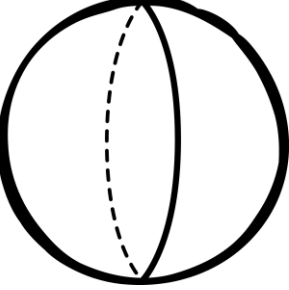
B 

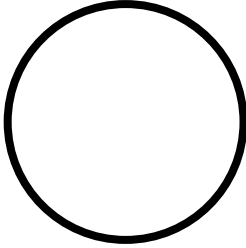
C 

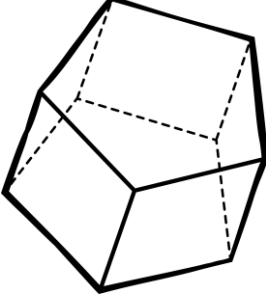
D 

Odd-one-Out Geometry Edition © Spivey Sparks 2017

11

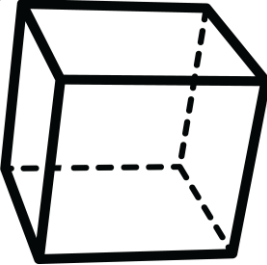
A 

B 

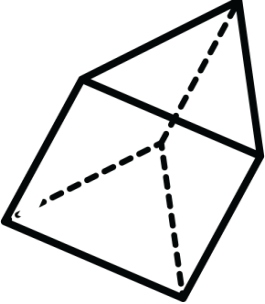
C 

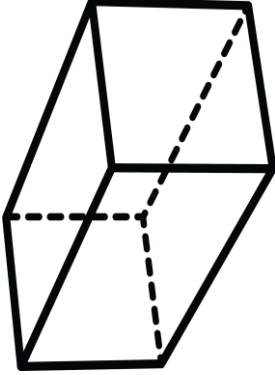
D 

Odd-one-Out Geometry Edition © Spivey Sparks 2017

12

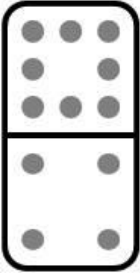
A 

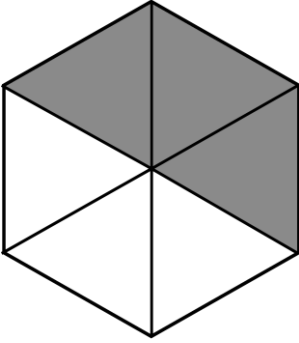
B 

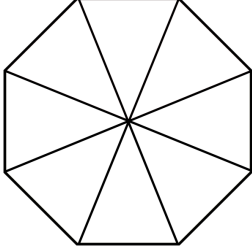
C 

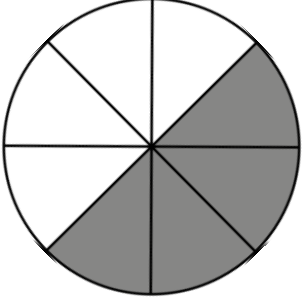
D 

Odd-one-Out Geometry Edition © Spivey Sparks 2017

13

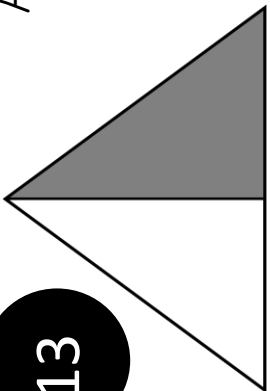
A 

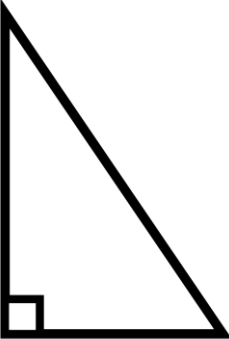
B 

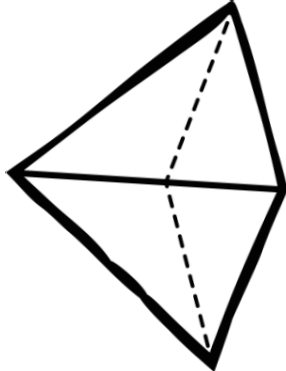
C 

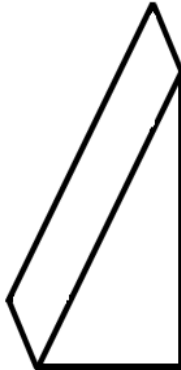
D 

Odd-one-Out Geometry Edition © Spivey Sparks 2017

14

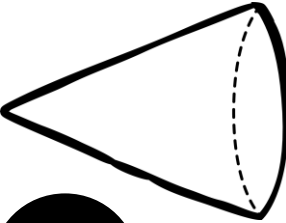
A 

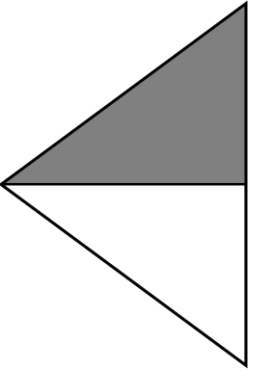
B 

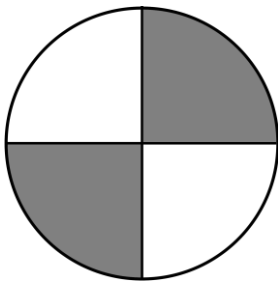
C 

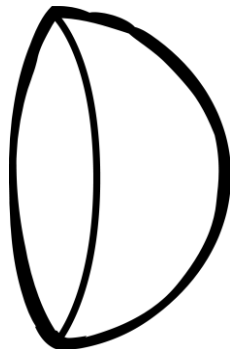
D 

Odd-one-Out Geometry Edition © Spivey Sparks 2017

15

A **W**

B **Z**

C **M**

D **Y**

Odd-one-Out Geometry Edition © Spivey Sparks 2017

16

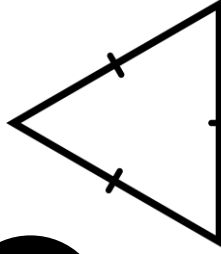
A 

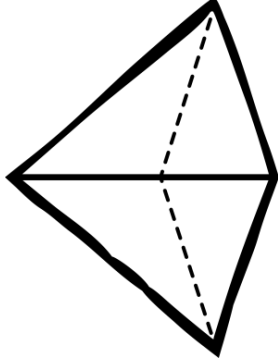
B 

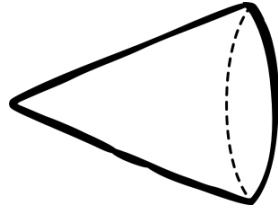
C 

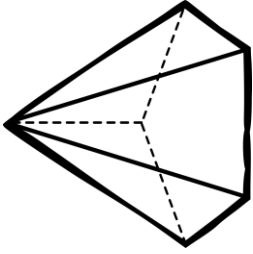
D 

Odd-one-Out Geometry Edition © Spivey Sparks 2017

17

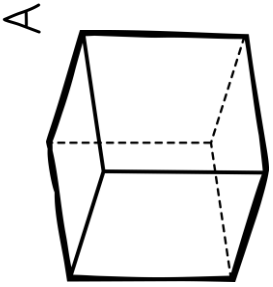

A

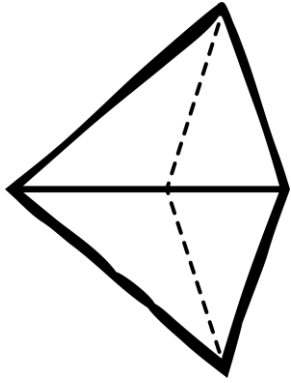

B

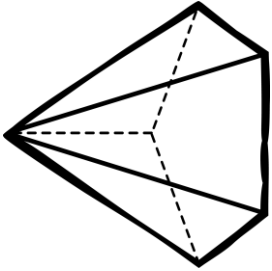

C

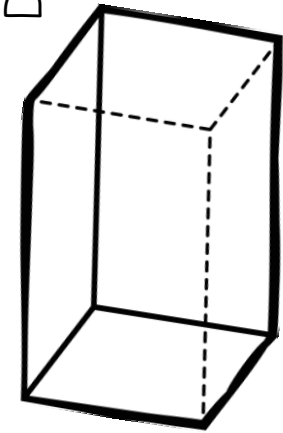

D

Odd-one-Out Geometry Edition © Spivey Sparks 2017

18

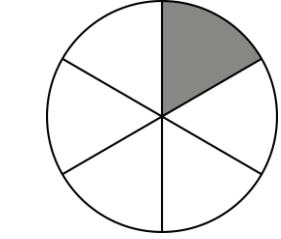

A

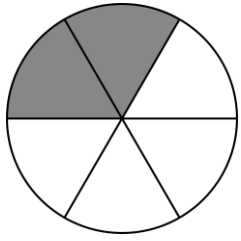

B

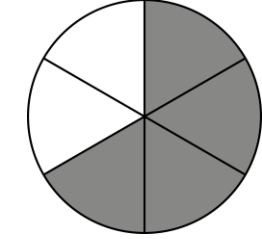

C

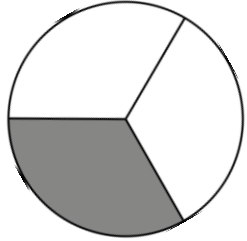

D

Odd-one-Out Geometry Edition © Spivey Sparks 2017

19

H

A

T

B

I

C

A

D

Odd-one-Out Geometry Edition © Spivey Sparks 2017

20

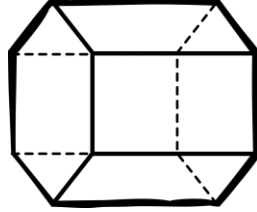

A

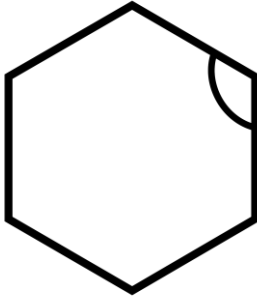

B

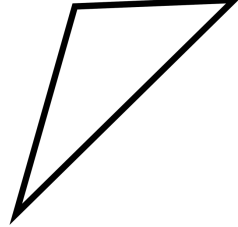

C

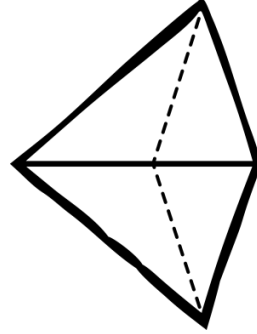

D

Odd-one-Out Geometry Edition © Spivey Sparks 2017

1

A

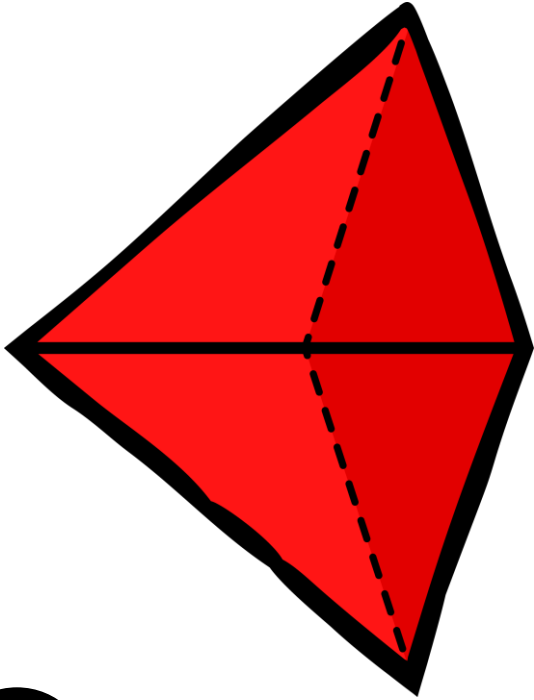

B

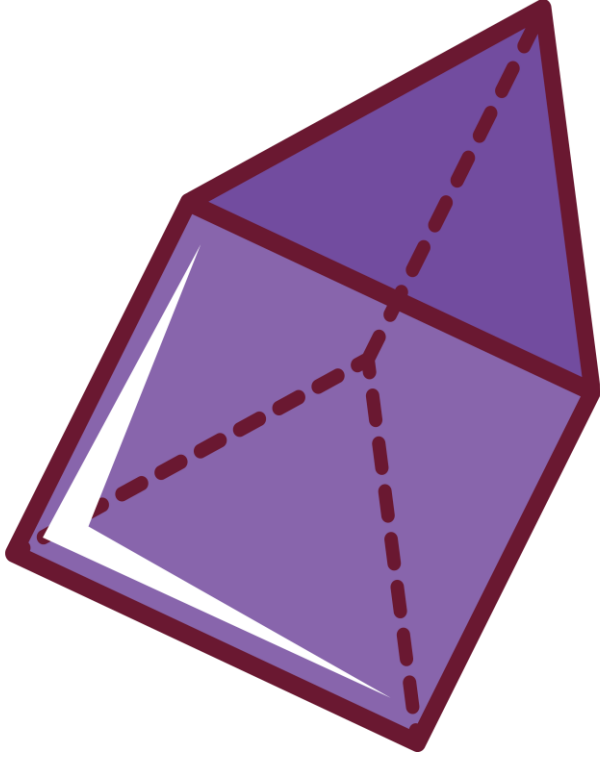

C

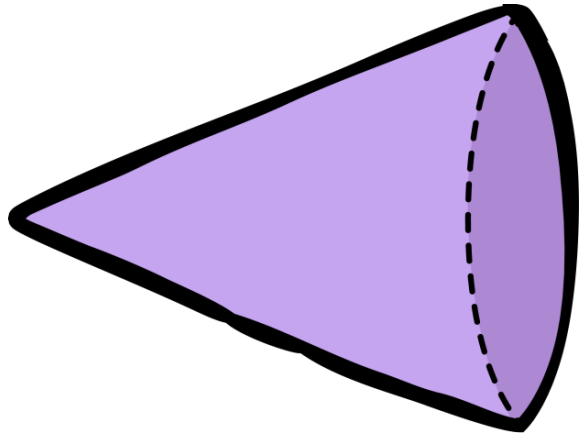

D

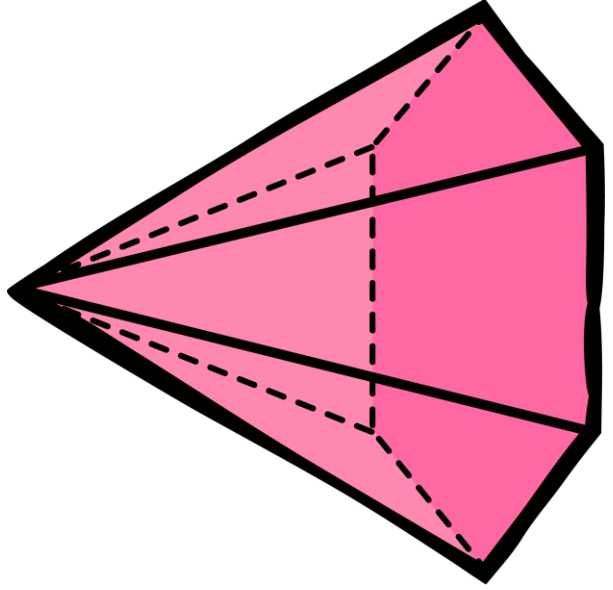

Odd-one-Out Geometry Edition

© Spivey Sparks 2017

2

A

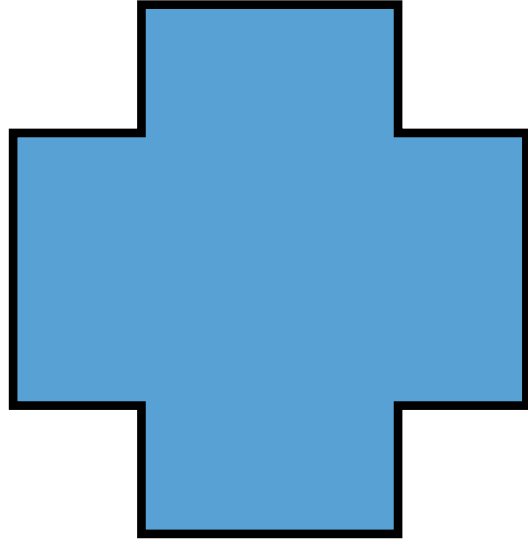

B

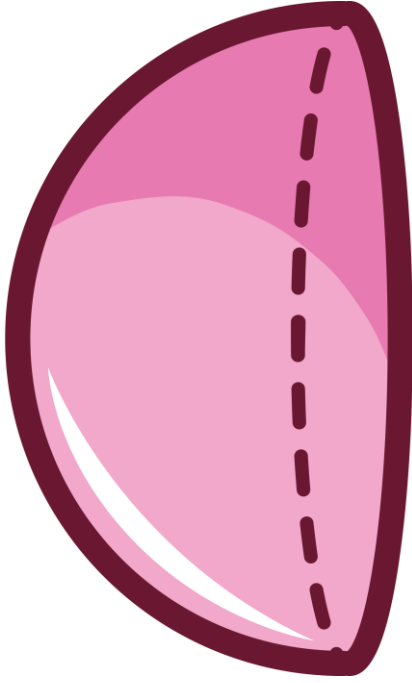

C

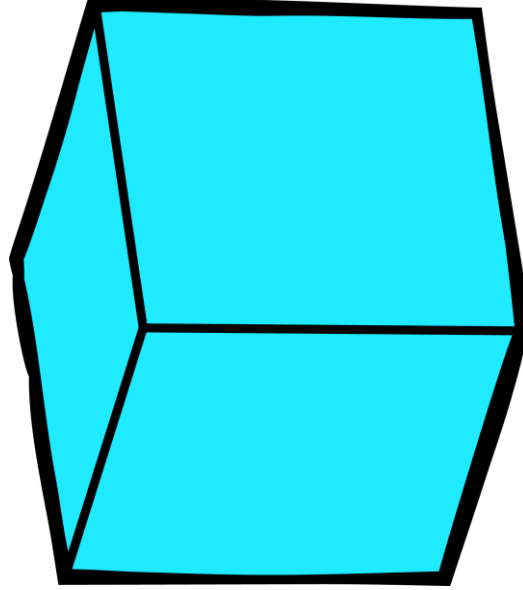

D

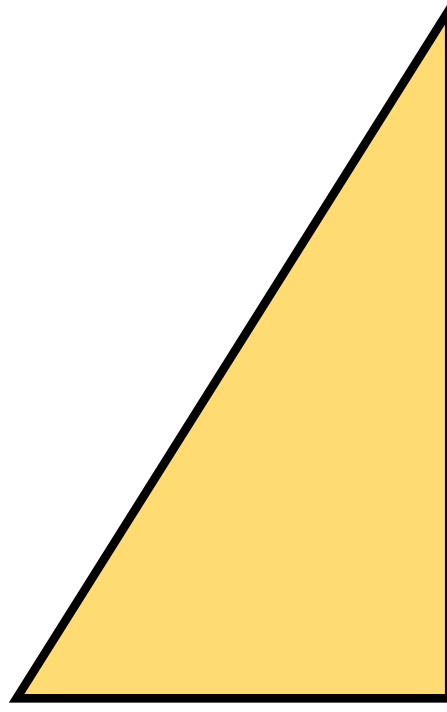

A

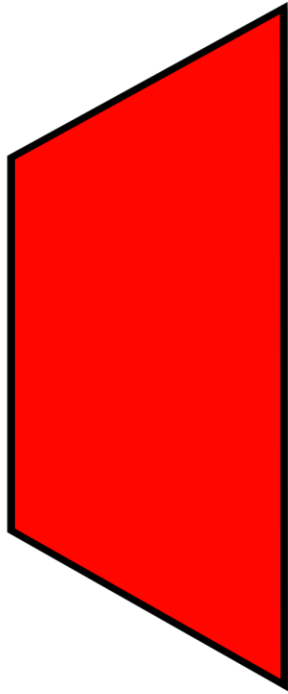

B

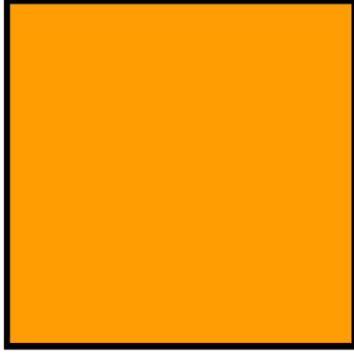

C

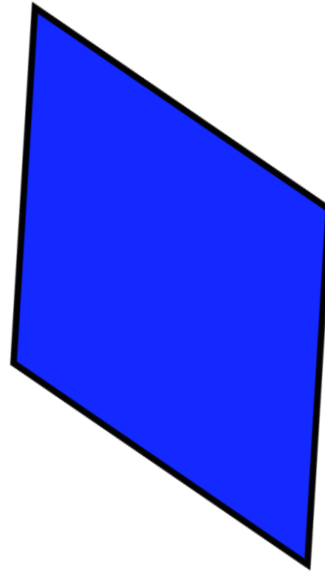

D

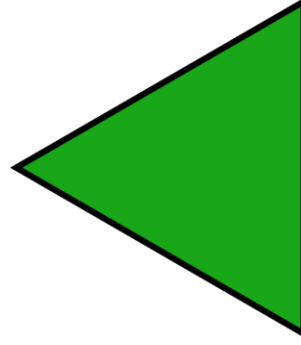

A

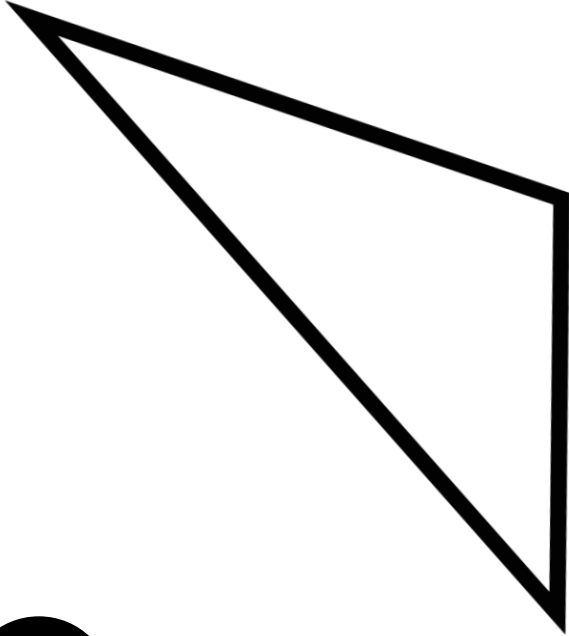

B

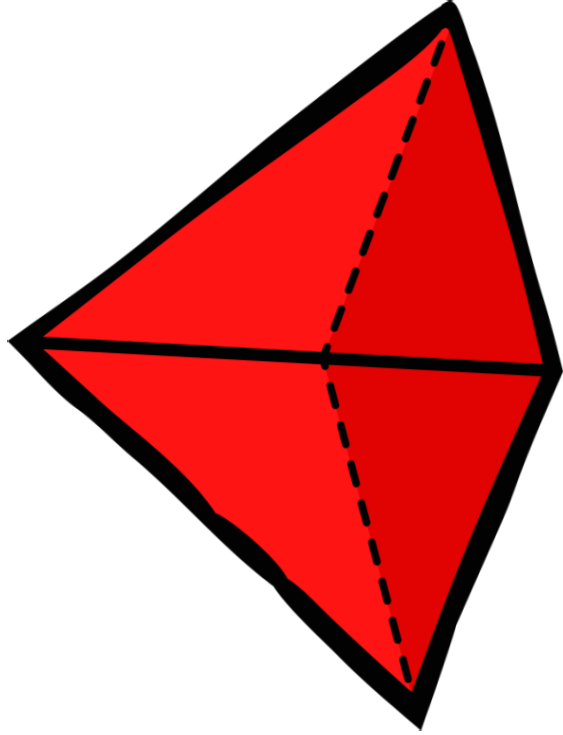

C

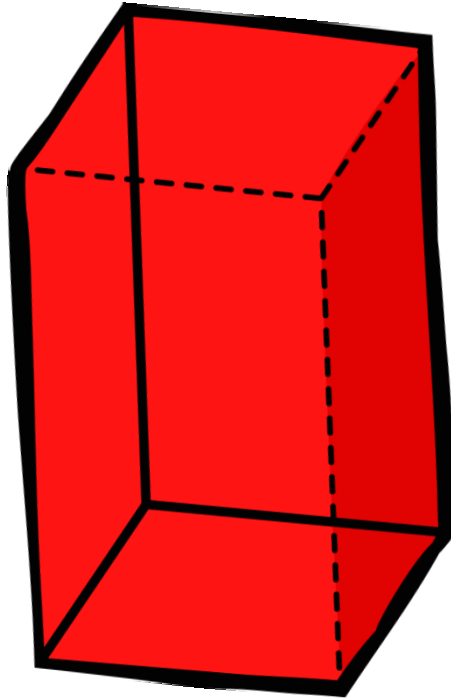

D

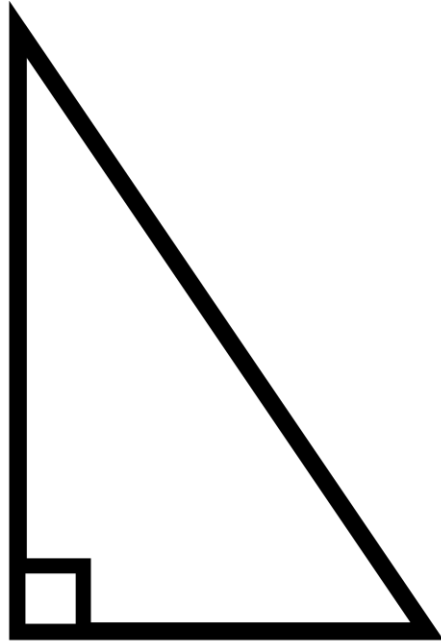

A

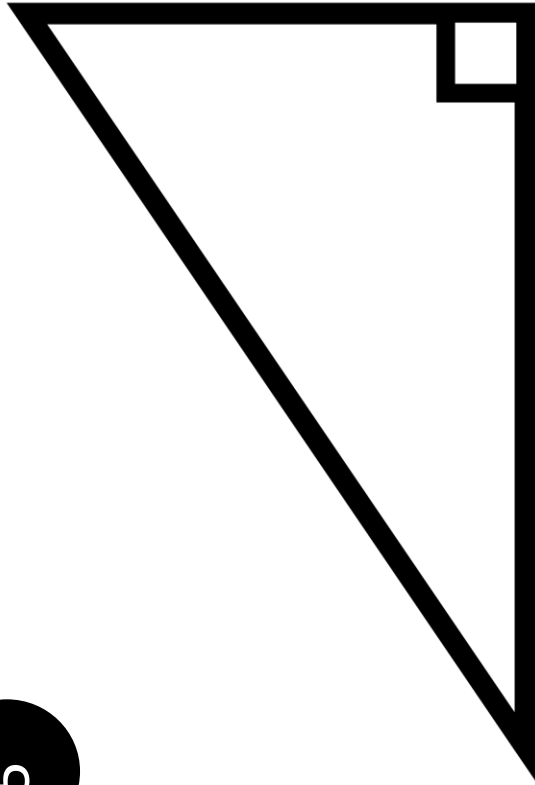

B

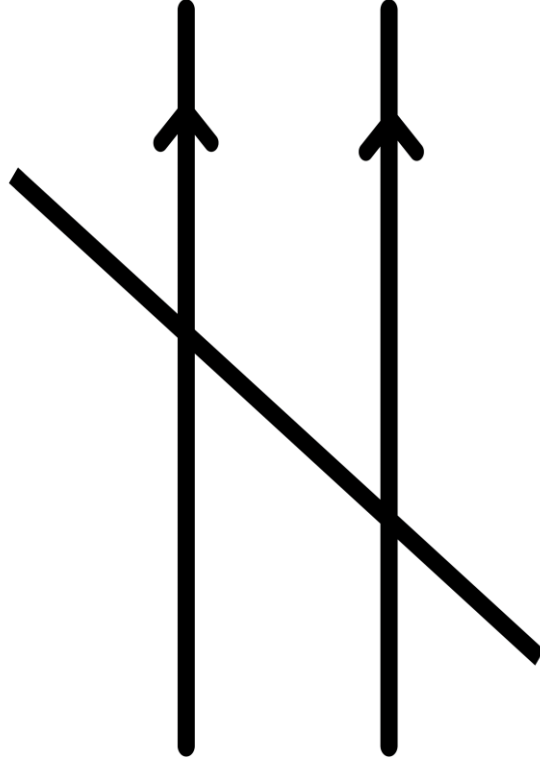

C

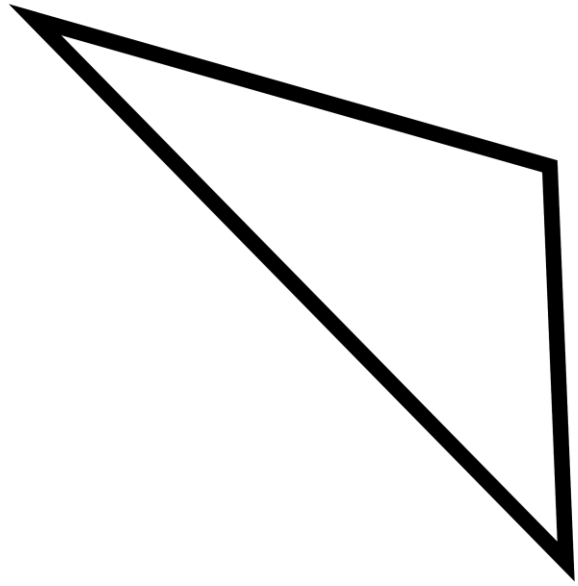

D

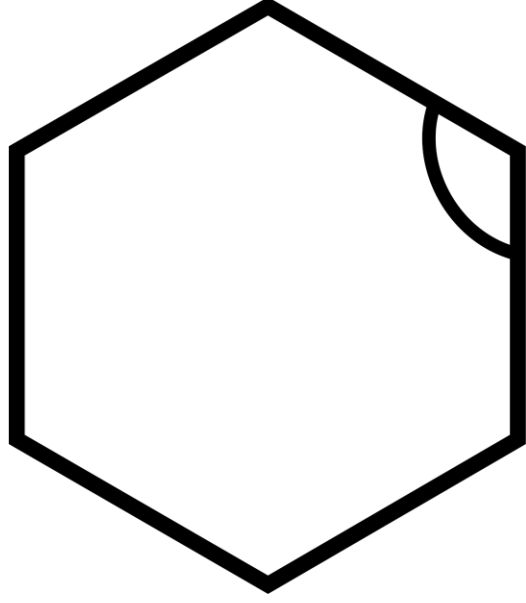

A

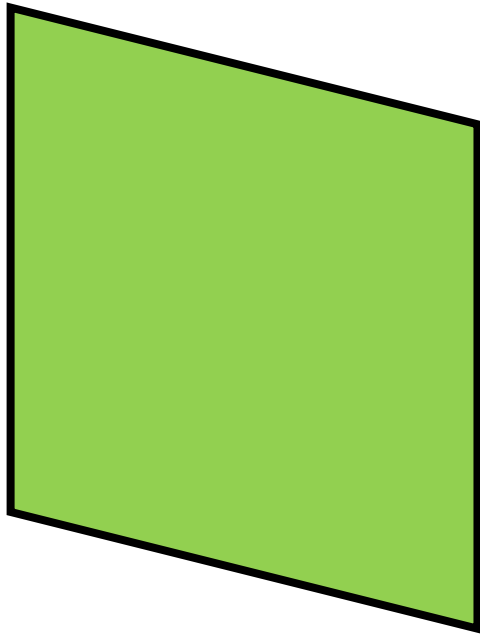

B

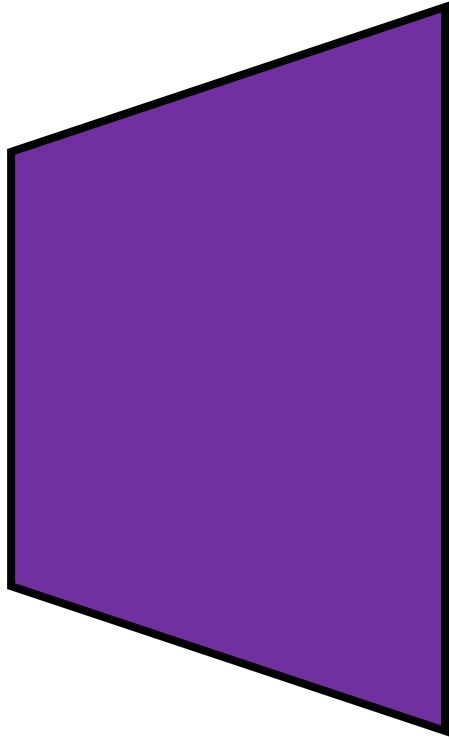

C

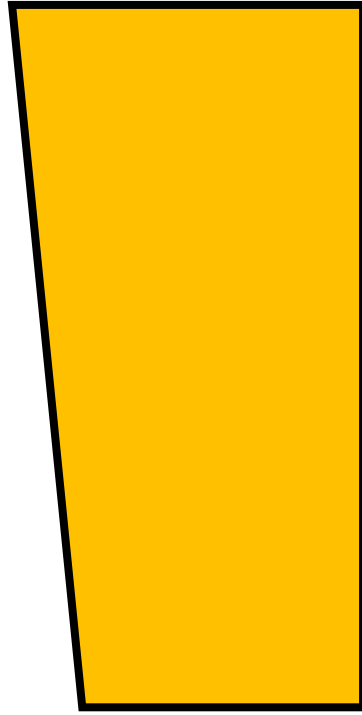

D

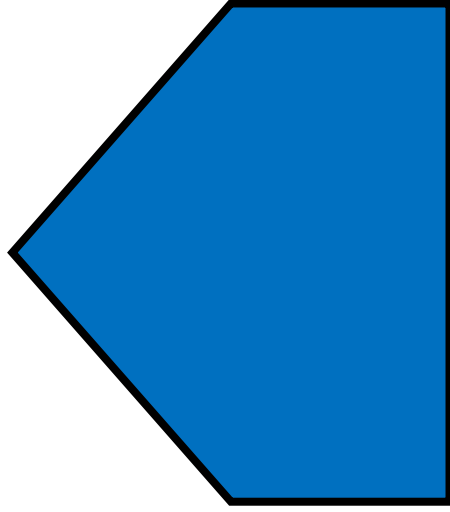

A

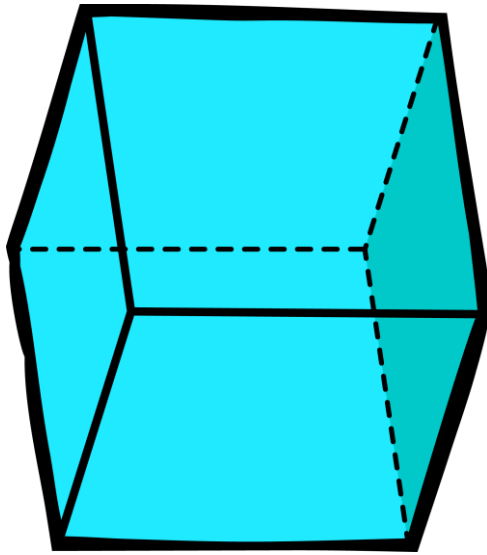

B

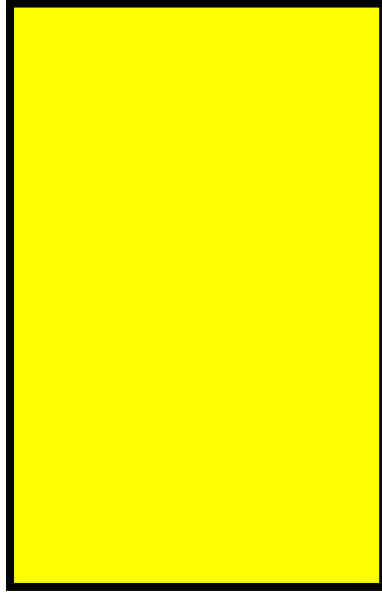

C

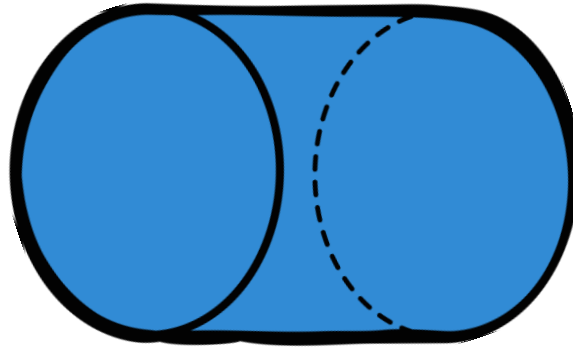

D

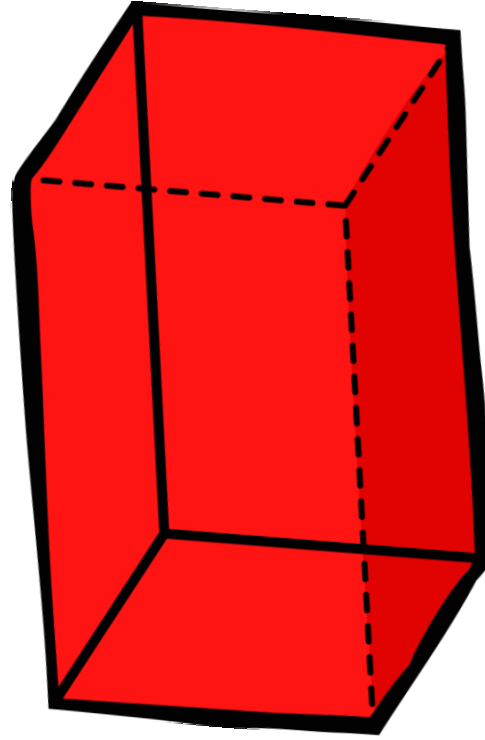

A

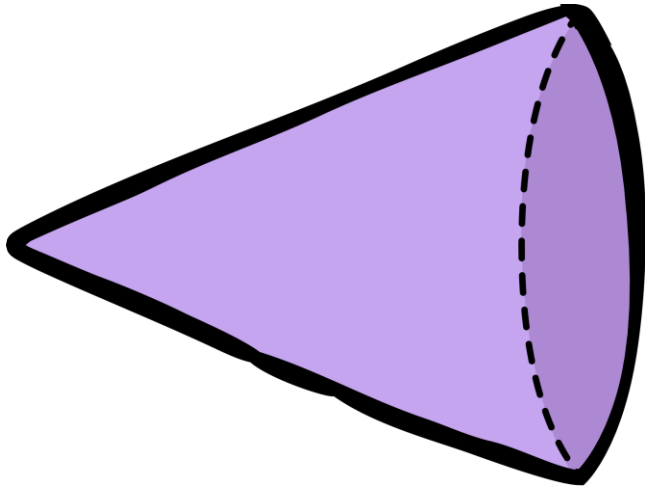

B

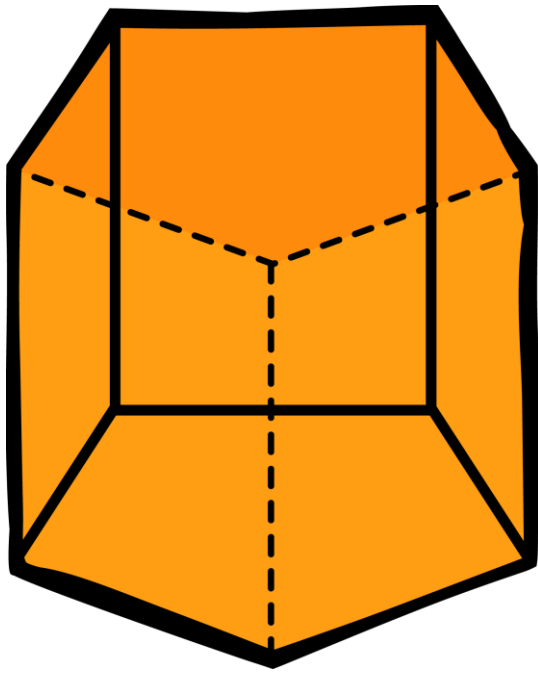

C

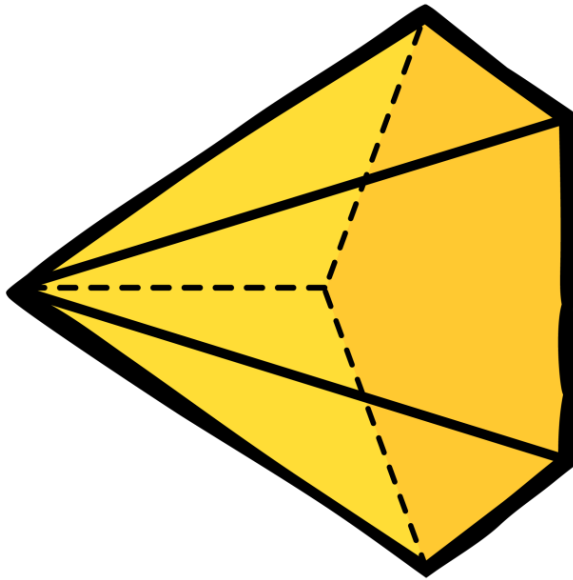

D

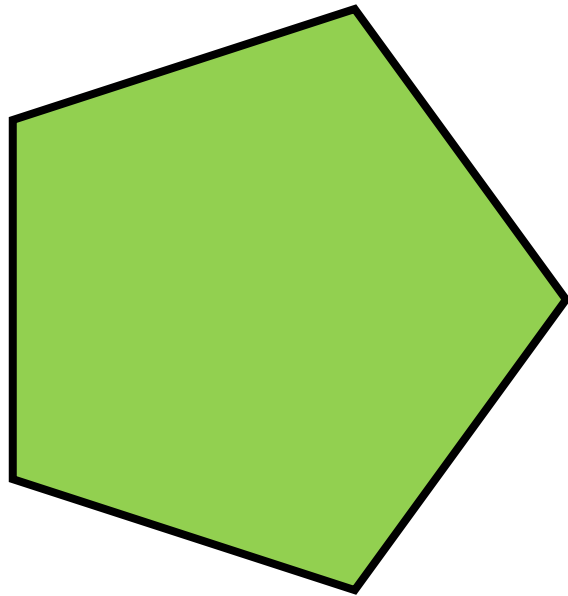

A

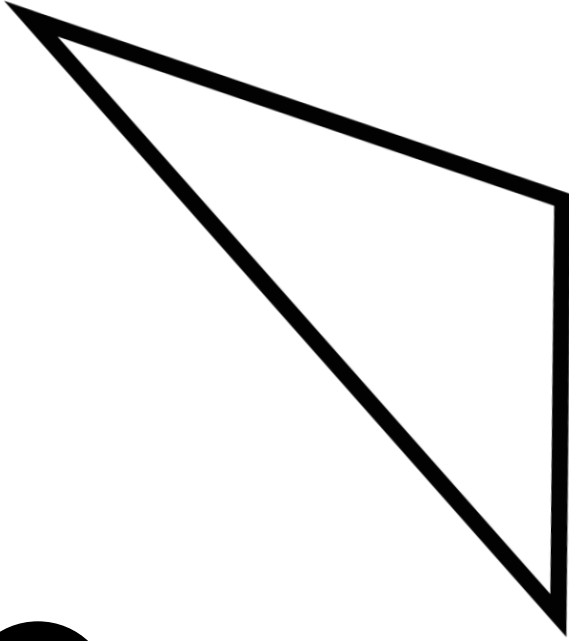

B

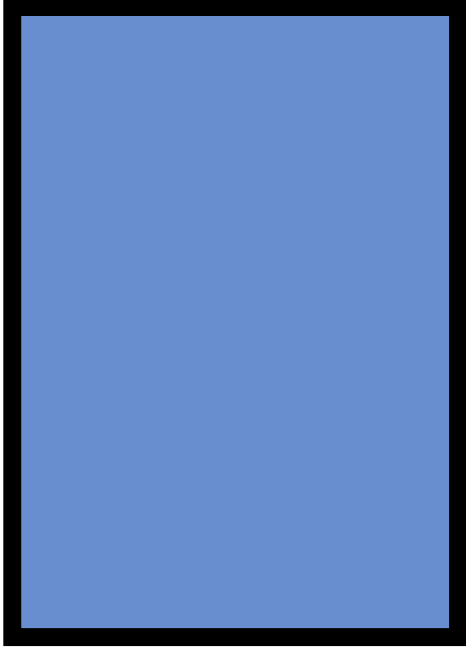

C

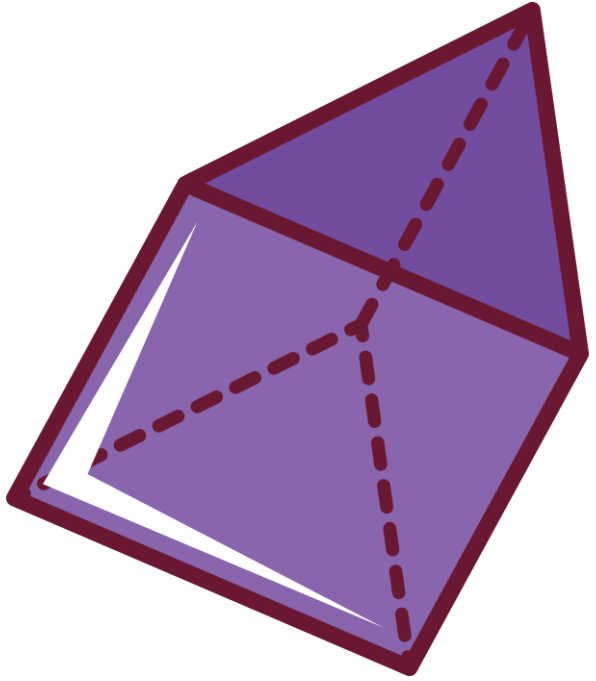

D

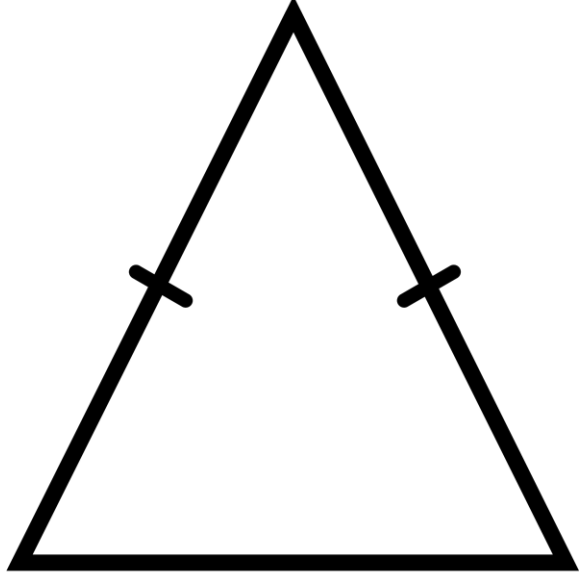

A

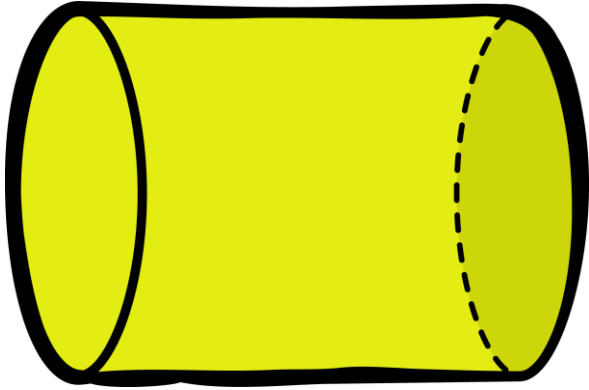

B

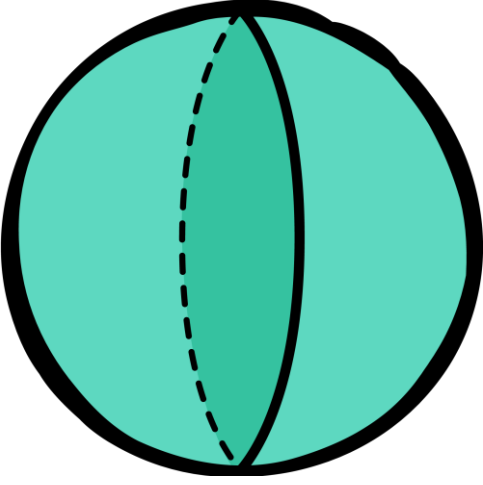

C

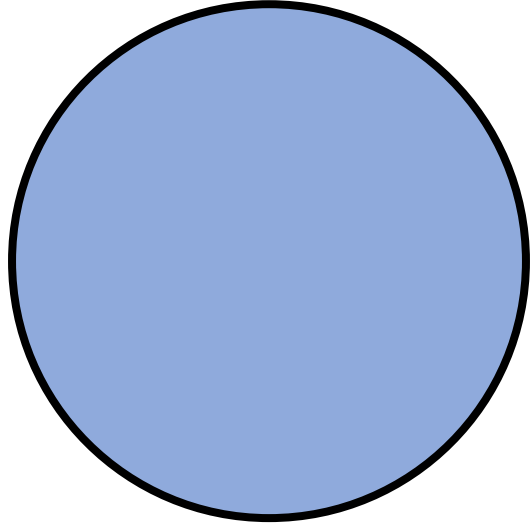

D

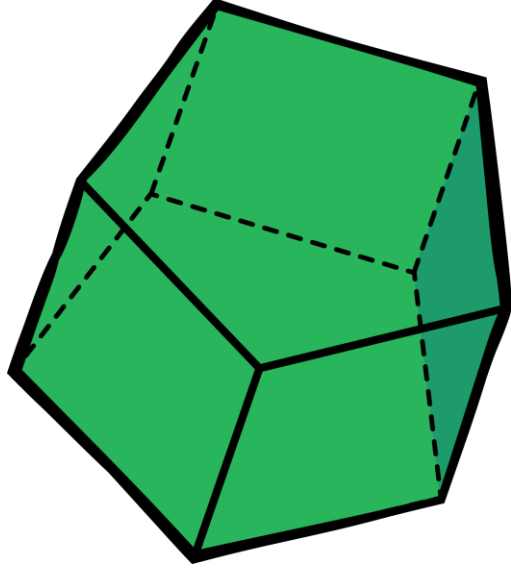

A

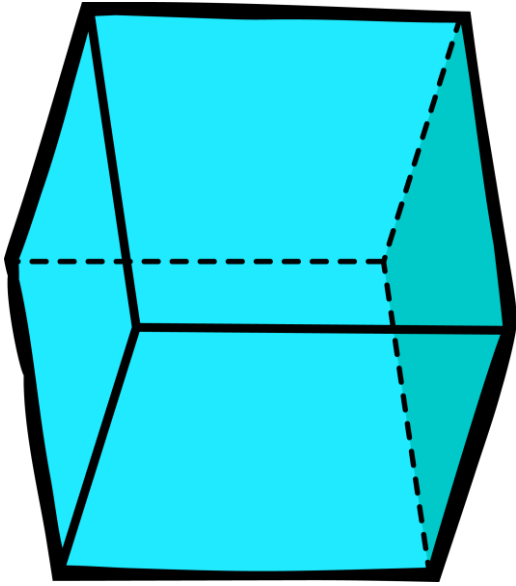

B

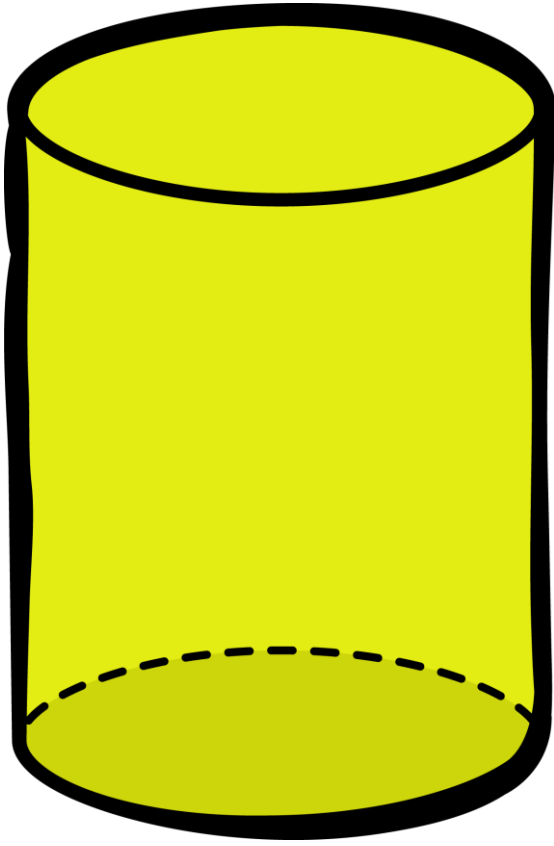

C

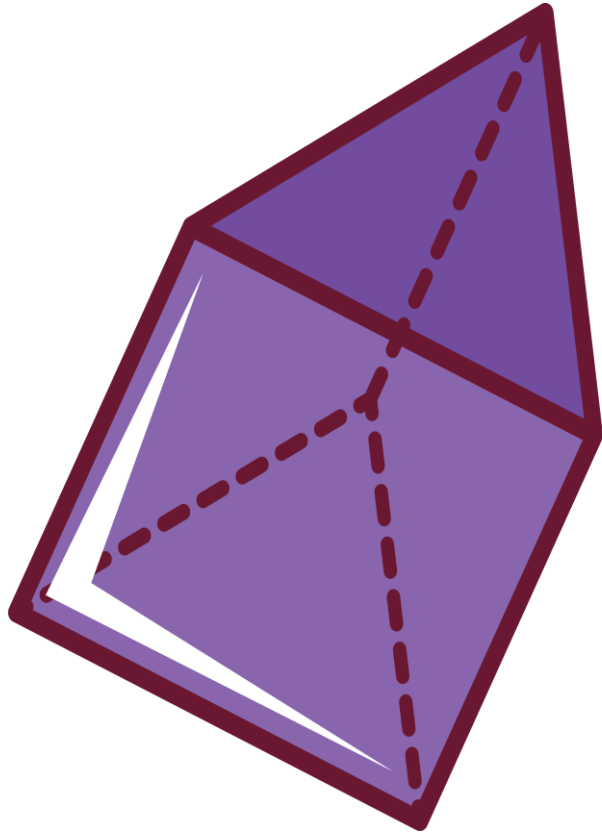

D

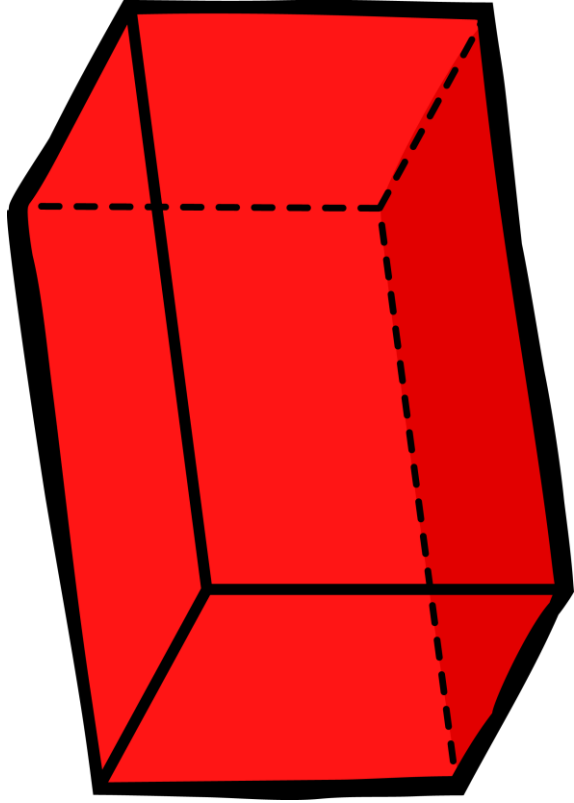

A

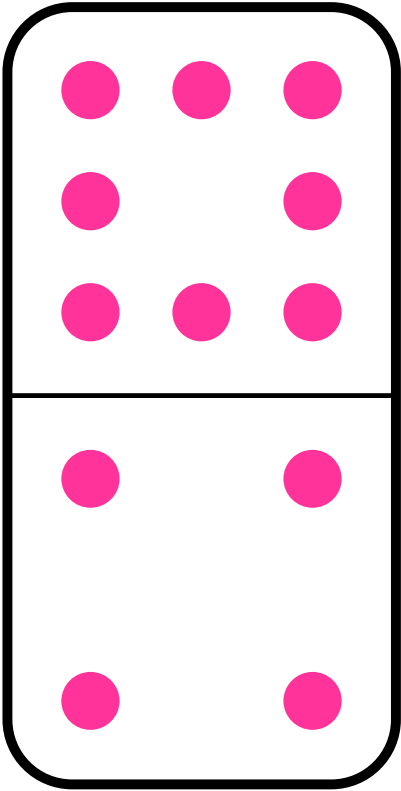

B

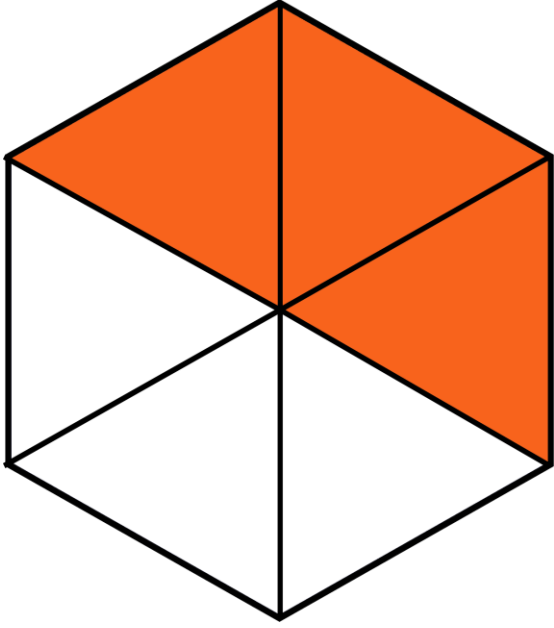

C

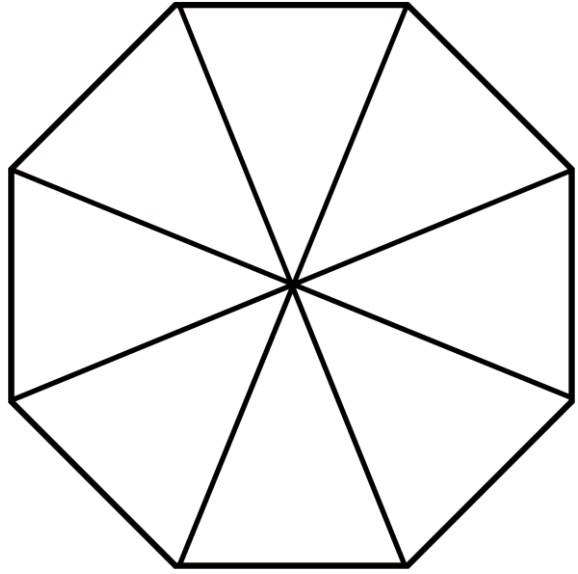

D

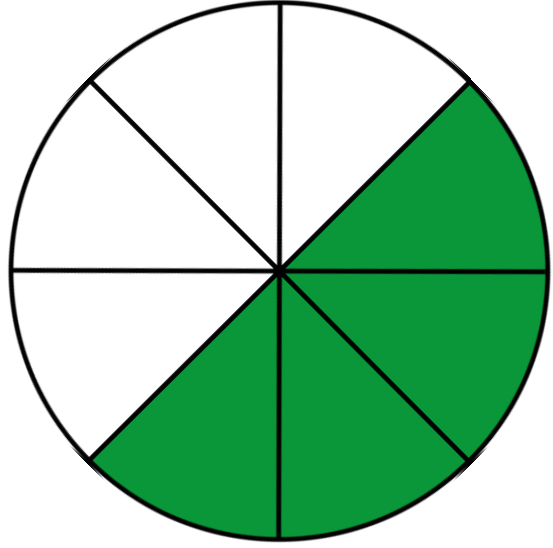

A

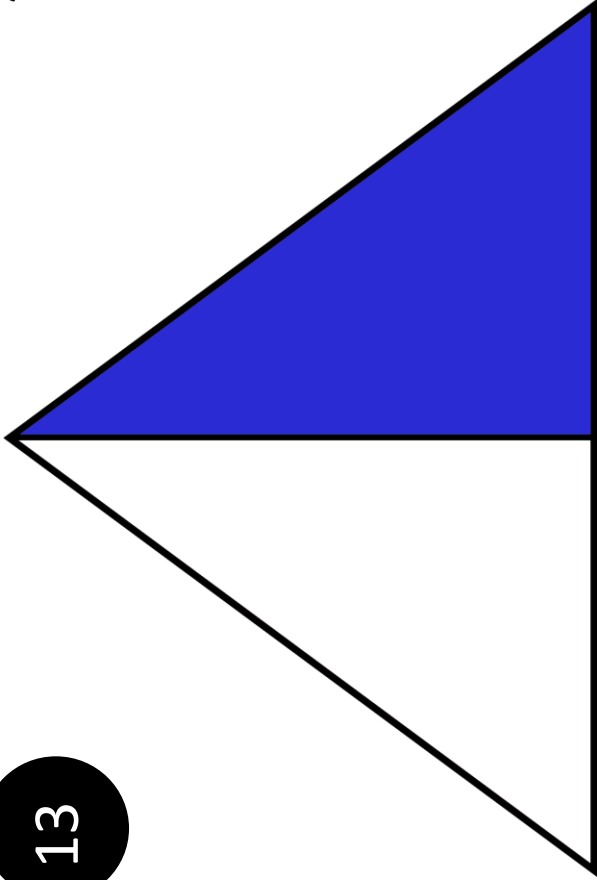

B

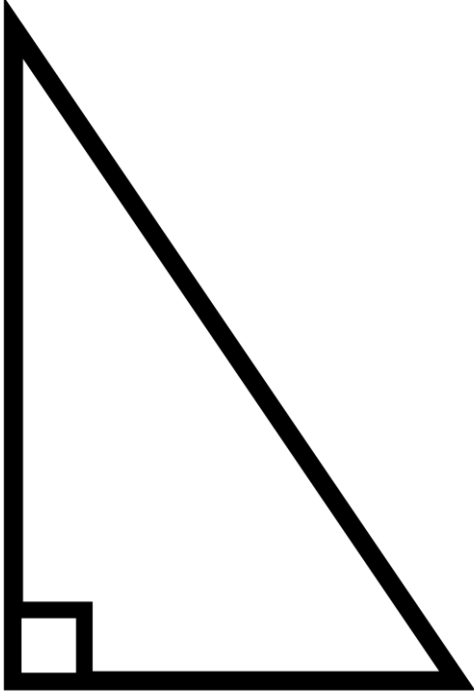

C

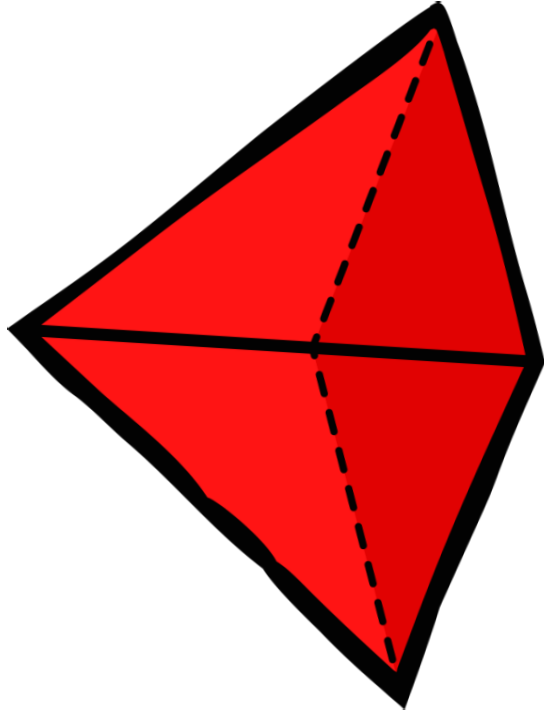

D

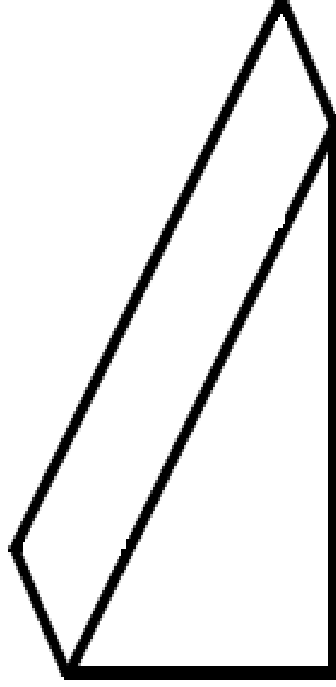

A

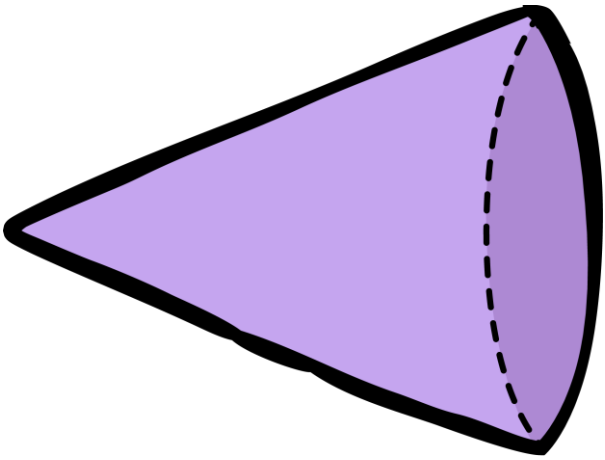

B

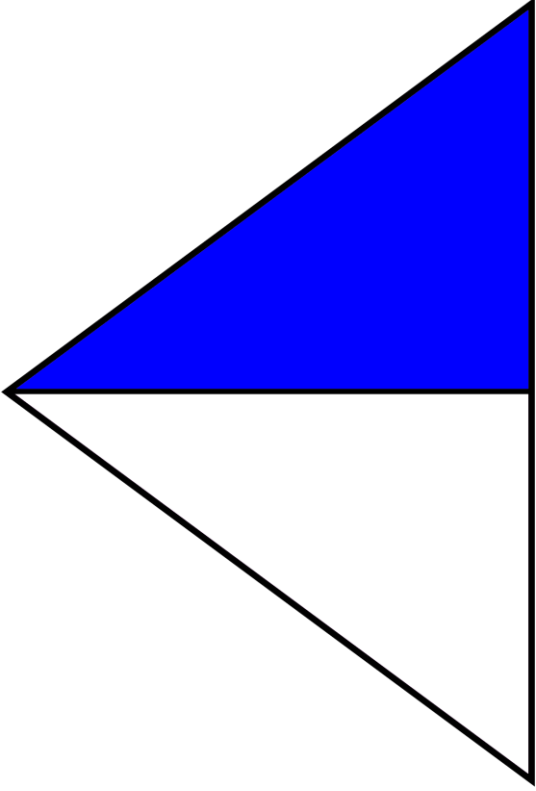

C

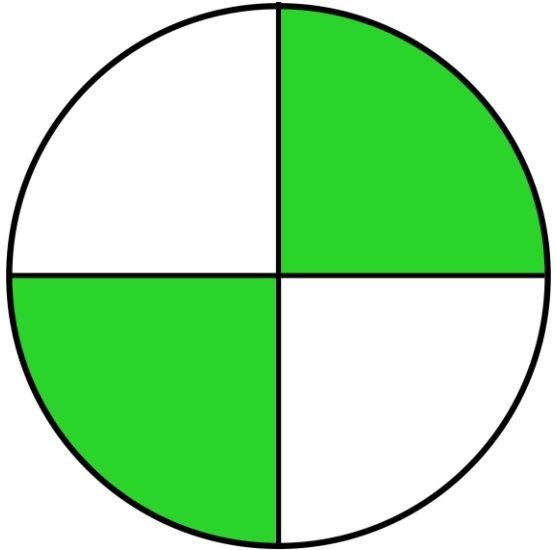

D

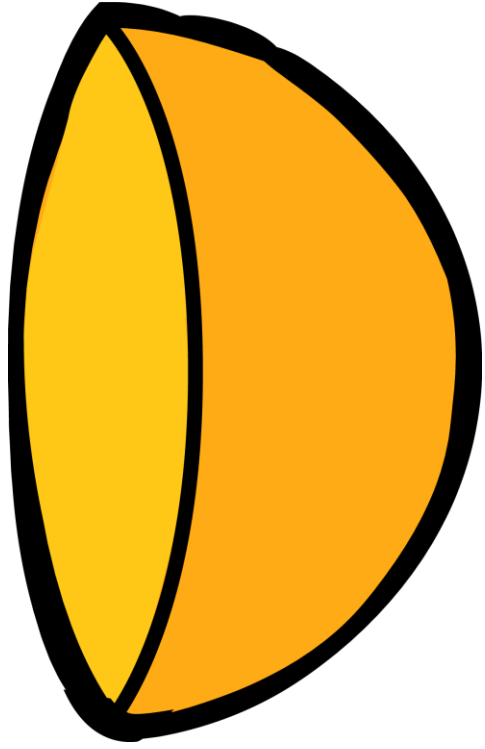

A

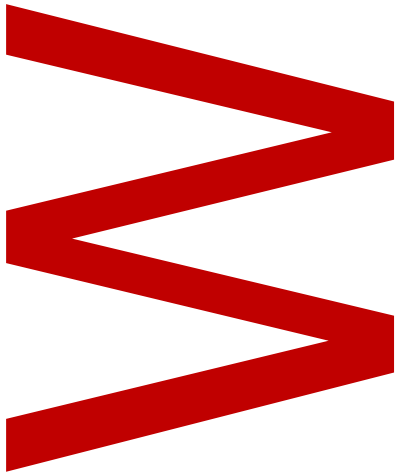

B

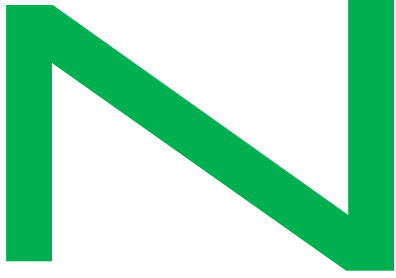

C

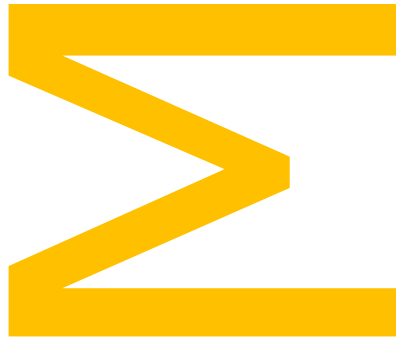

D

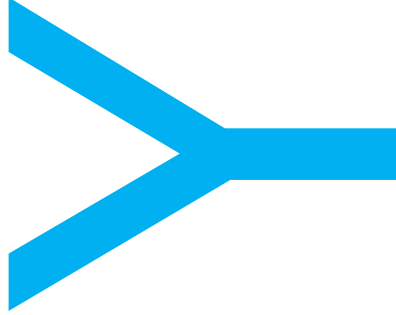

A

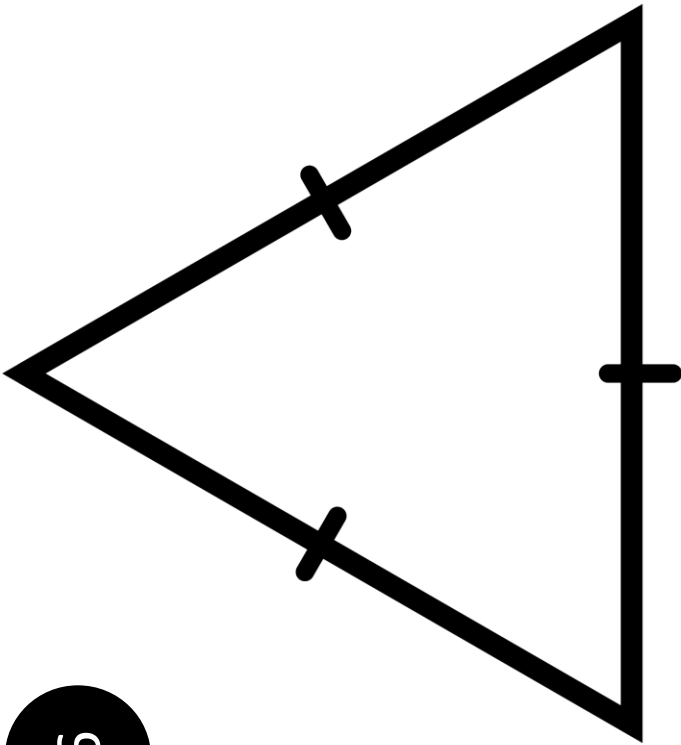

B

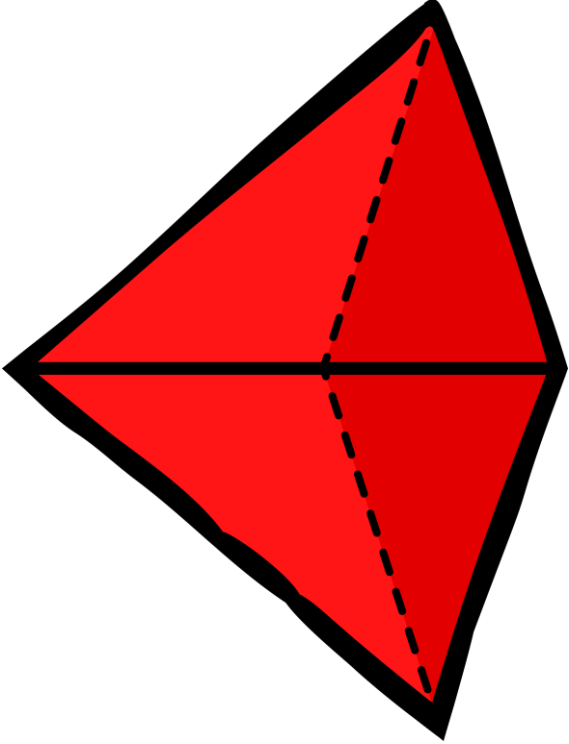

C

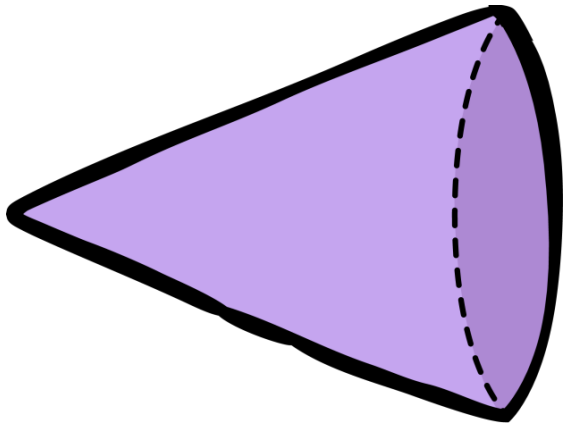

D

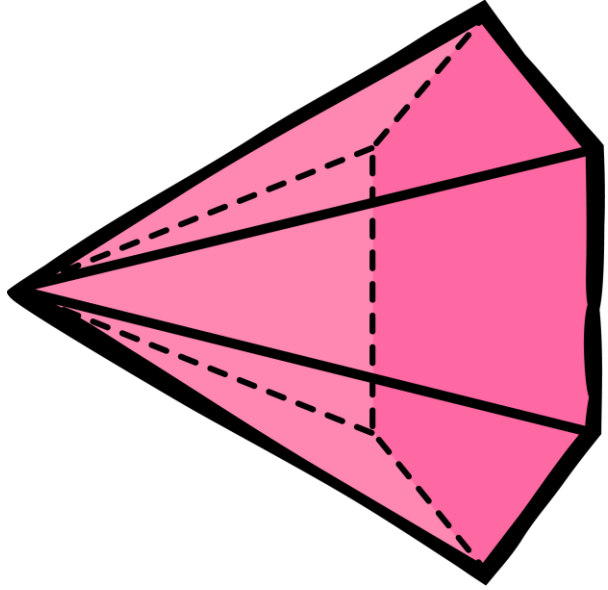

A

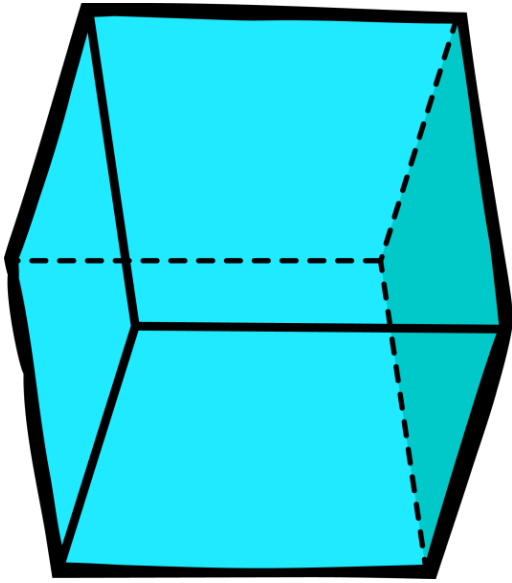

B

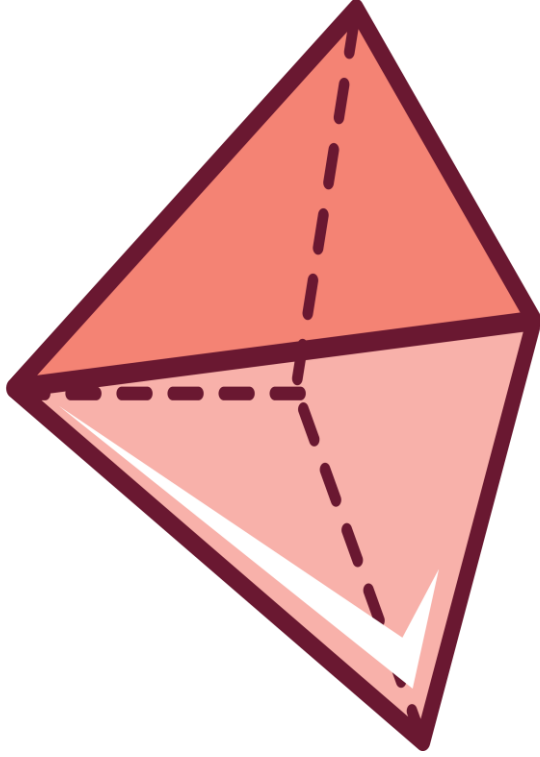

C

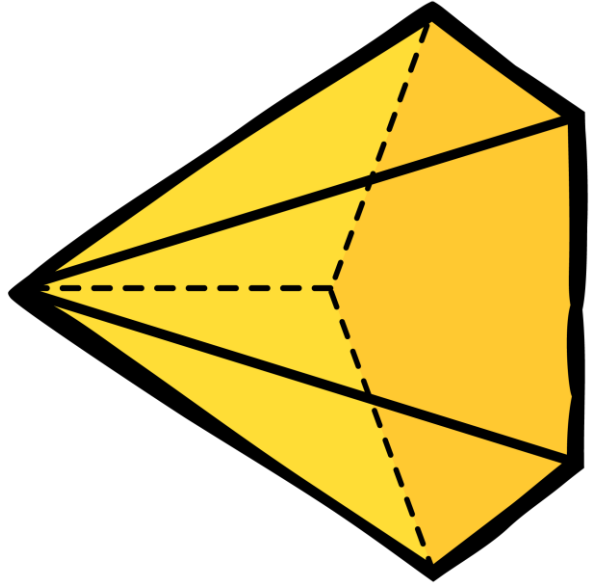

D

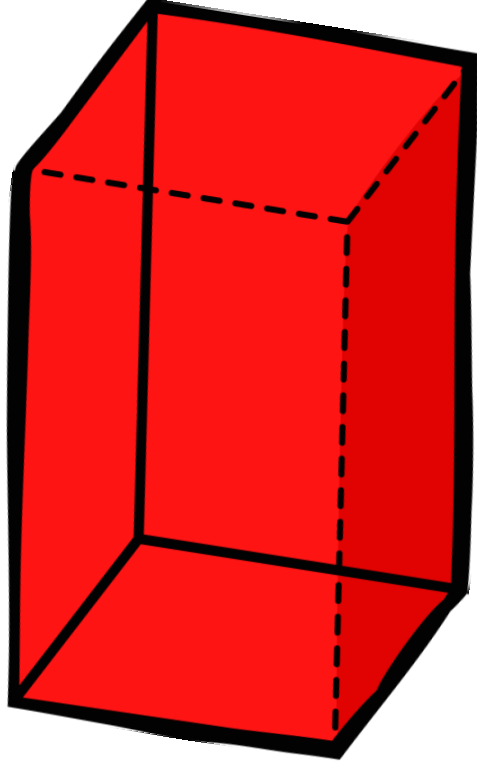

A

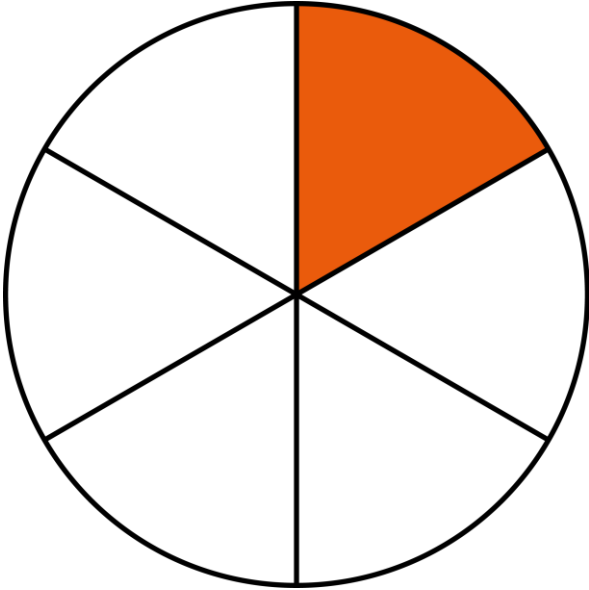

B

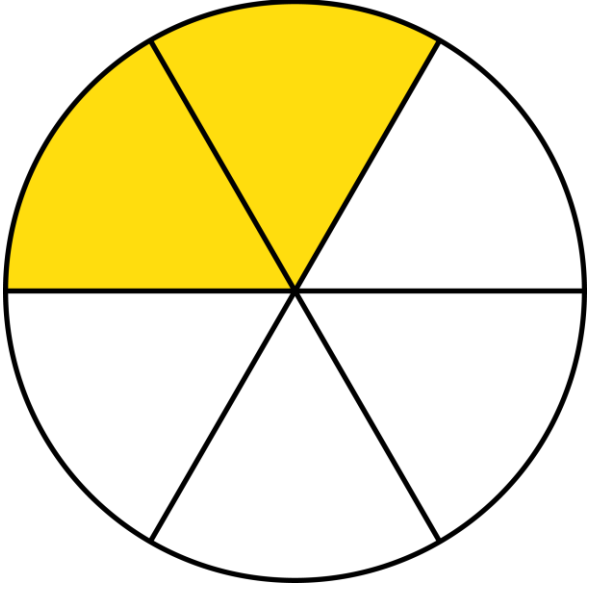

C

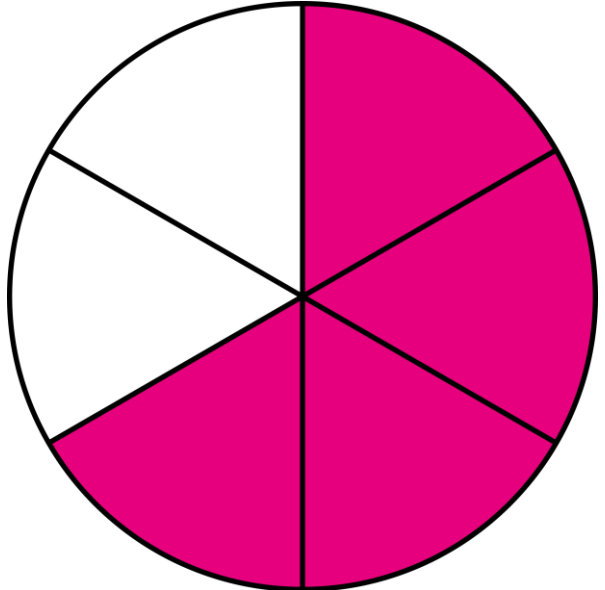

D

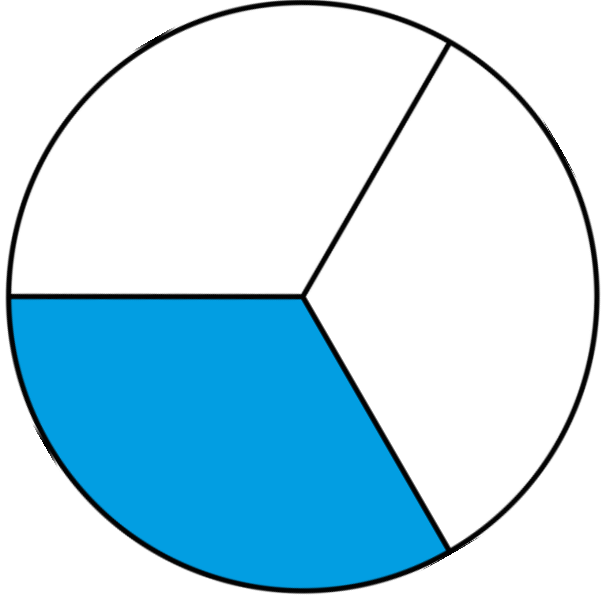

A

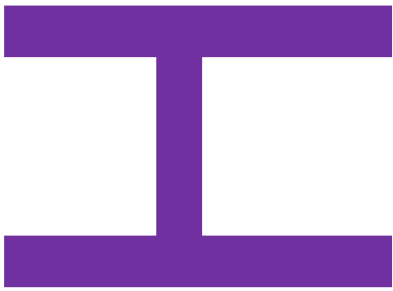

B



C



D

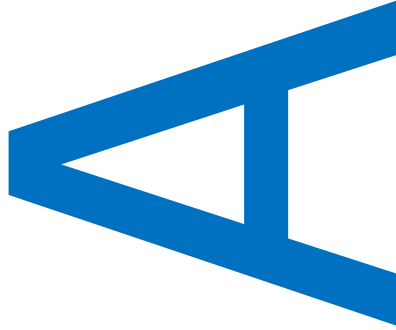

A

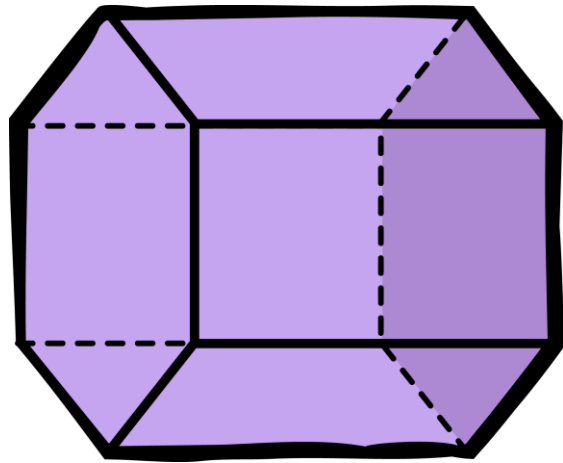

B

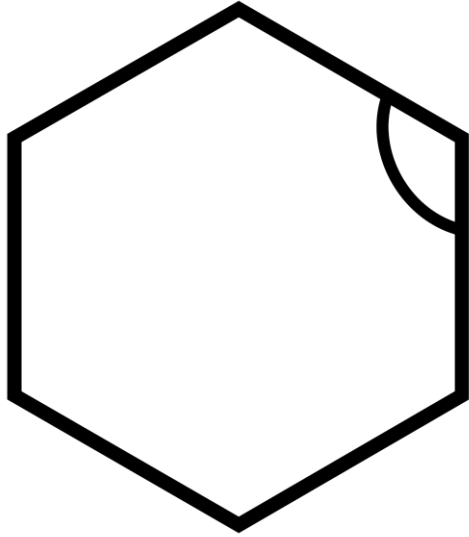

C

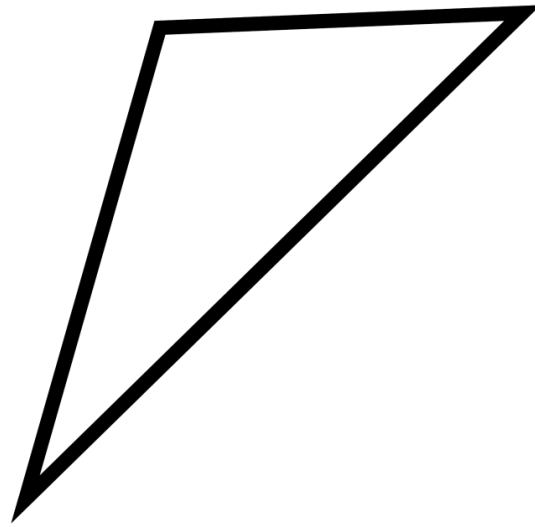

D

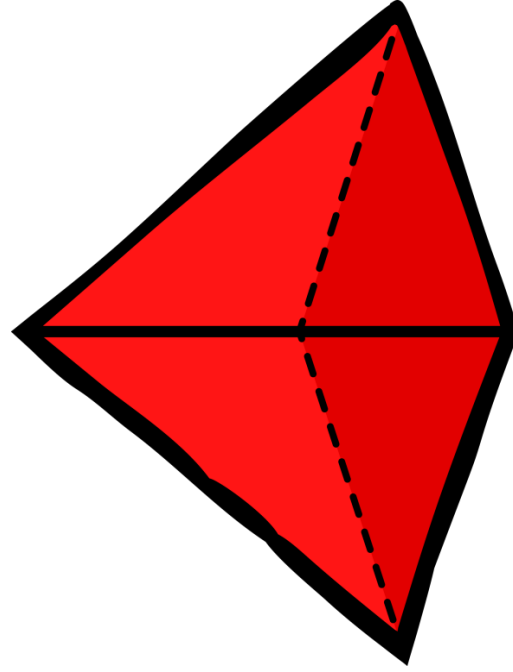

Name: _____

Date: _____

Odd-one-Out

Answer Sheet

Use **MATHEMATICAL** reasoning to explain why one picture is the odd-one-out. There are more than one possibility per card. Write the letter of at least one answer in each box below.

1.

2.

3.

4.

5.

6.

7.

8.

9.

10.

11.

12.

13.

14.

15.

16.

17.

18.

19.

20.

Name: _____

Card # _____

Constructed Response: use **MATHEMATICAL** reasoning to explain why one picture is the odd-one-out. There are more than one possibility per card. Explain your thinking.

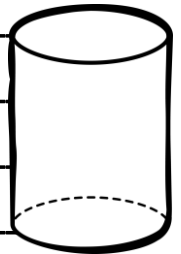

Odd-one-Out Geometry Edition

© Spivey Sparks 2017

Name: _____

Card # _____

Constructed Response: use **MATHEMATICAL** reasoning to explain why one picture is the odd-one-out. There are more than one possibility per card. Explain your thinking.

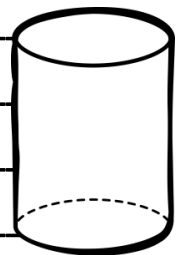

Odd-one-Out Geometry Edition

© Spivey Sparks 2017

Sample Answers

Additional answers are possible, with mathematical reasoning.

1. C: Its base is not a polygon
 2. B: No right angles
 3. D: Not a quadrilateral
 4. C: Has only right angles
 5. A: No obtuse angle
 6. A: Two sets of parallel sides
 7. B: Not a solid figure
 8. A: No pentagonal face
 9. A: Includes an obtuse angle
 10. B: Has no faces
 11. B: It rolls
 12. A: Not a polygon
 13. B: Only includes one triangle
 14. A: Does not show half
 15. B: No line of symmetry
 16. B: Has perpendicular lines
 17. B: Does not have six faces
 18. A: No third equivalence
 19. B: Made with two line segments
 20. C: No parallel lines
- B: It does not have an apex
 - D: Not symmetrical
 - B: Cannot make a hexagon
 - A: No perpendicular lines
 - B: Not a polygon
 - D: Not a quadrilateral
 - C: No right angles
 - B: Has right angles
 - B: Not a type of a triangle
 - D: Has angles
 - C: Odd number of faces
 - C: Does not show half
 - C: Not a right triangle
 - B: No circular face
 - D: Includes obtuse angles
 - C: No triangular face
 - C: No square face.
 - D: Denominator is not six
 - D: No perpendicular lines
 - D: No obtuse angles

Thank You!

Terms of Use:

This product was created for TpT. Each page is copywrite protected. Your digital download is for use by one teacher within your classroom. It may not be uploaded to another site. If more teachers would like to use these activities, please return to your purchase page to buy additional licenses,

at a discounted price.

Let's Stay
Connected!



to earn tpt credits:

After reviewing my product, please return to your purchase page & leave feedback.

~SPIVEY SPARKS~

Thank you to these teacher authors for fonts, frames, and clip art! Click buttons to check out their TpT stores.

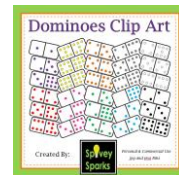
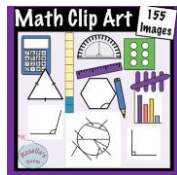

Check Out These CREATIVE Thinking Resources!

Finish the
Picture

with
CREATIVE
Thinking



Fall Edition



Finish the
Picture

with
CREATIVE
Thinking



Winter Edition



Fostering
CREATIVE
Thinking
with
SCAMPER



Design-a-Toy
with
BLOCKS

using
CREATIVE
Thinking

